



Model

ISO MIX 150 USW1 - SILENT MIX FLOW FAN

Description

150mm silent inline mix flow duct fan, 2 speed switching & 1.2m power cord

Application

Kitchens / Commercial / Apartments / Industrial

Technical specification

Voltage [V/50 Hz]	220-240 AC
Power [W]	45-52
Current [A]	0.20-0.23
Extract capacity [m ³ /h]	410-550
Noise level 3m [dBA]	26-33
r.p.m.	1985-2640
Installation type	Inline duct
Installation position	Any
DN (diameter nominal) [mm]	150
Air flow temperature [°C]	-25 - +60
Index of protection	IP X4
Internal thermal protection	Manual reset
Colour	Blauberg grey
Casing material	Polymer- coated steel
Warranty	5 years

Characteristic curve

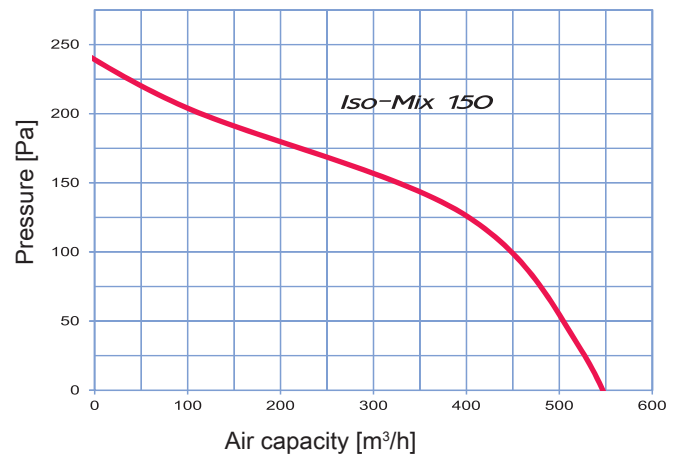

Dimensions [mm]

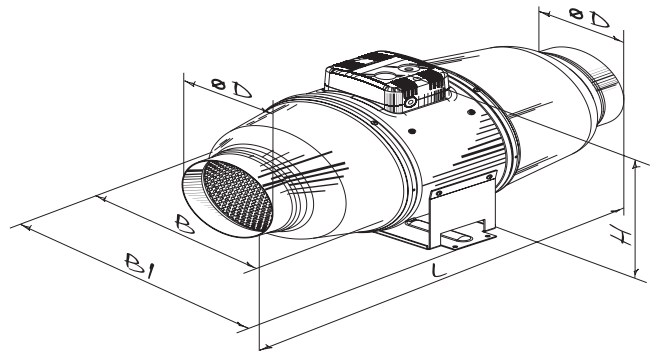

Type	Dimensions [mm]				
	d	b	b1	l	h
ISO MIX 150 USW1	148	247	273	579	263

Sound power levels

Sound pressure level	Octave-frequency band [Hz]								
	Gen	63	125	250	500	1000	2000	4000	8000
LwA to inlet, dBA	61	25	33	49	55	53	55	53	39
LwA to outlet, dBA	59	35	36	51	55	55	55	40	42
LwA to environment, dBA	39	19	22	39	35	36	36	24	21

Ventilation Solutions Australia (VSA) is not responsible for mistakes or printing errors and retain the right to make technical modifications without giving prior notice.

Email: info@ventilationsolutions.com.au
 Phone: 1300 998 326

