



Model

TURBO 100 USW1 T - MIX FLOW FAN

Description

100mm inline mix flow duct fan, 2 speed exterior switching, adjustable run on-timer (2-30) minutes and 1.2m 4 pin power cord

Application

Bathrooms / Toilets / Ensuites / laundries / Commerical / Apartments

Technical specification

Voltage [V/50 Hz]	220-240 AC
Power [W]	23-25
Current [A]	0.10-0.11
Extract capacity [m ³ /h]	170-220
Noise level 3m [dBA]	27-32
r.p.m.	1980-2545
Installation type	Inline duct
Installation position	Any
DN (diameter nominal) [mm]	100
Air flow temperature [°C]	-20 - +60
Index of protection	IP X4
Internal thermal protection	Manual reset
Colour	Blauberg grey
Casing material	ABS plastic
Warranty	5 years

Characteristic curve

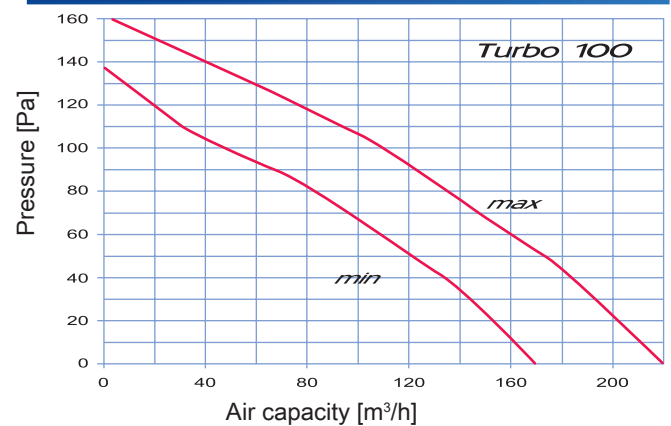

Dimensions [mm]

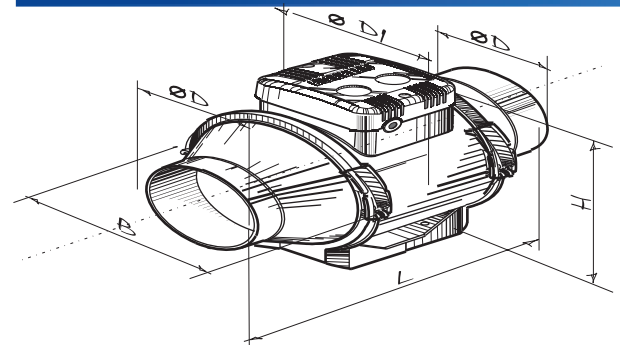

Type	Dimensions [mm]				
	d	d1	b	h	l
Turbo 100 USW1 T	98	164	196	241	303

Sound power levels

Sound pressure level	Octave-frequency band [Hz]								
	Gen	63	125	250	500	1000	2000	4000	8000
LwA to inlet, dBA	47	23	21	37	41	44	42	37	27
LwA to outlet, dBA	48	24	24	38	42	45	38	38	26
LwA to environment, dBA	37	20	19	23	30	34	26	26	17

Ventilation Solutions Australia (VSA) is not responsible for mistakes or printing errors and retain the right to make technical modifications without giving prior notice.

Email: info@ventilationsolutions.com.au
 Phone: 1300 998 326

